

Calibration
Kalibrierung
Kalibrering

Kalibrering
Kalibrering
Étalonnage

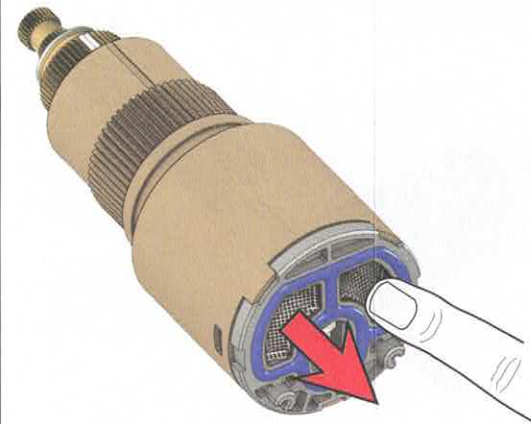

Citric acid/Vinegar
Zitronensäure/Essig
Citronsyre/Eddike
Citronsyra/Ättika
citroenzuur/Azijn
Acide citrique/Vinaigre



120 min

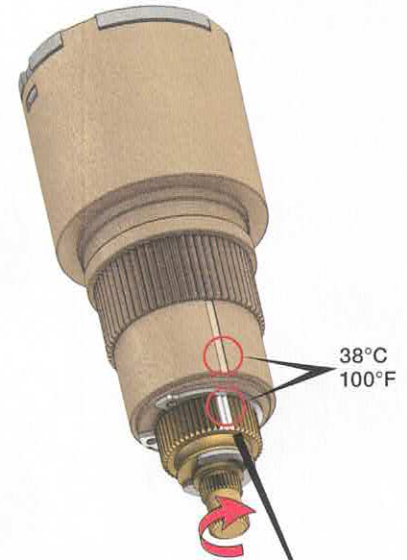
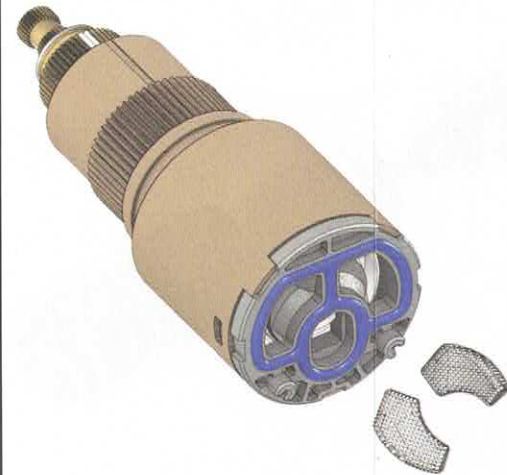

38°C
100°F

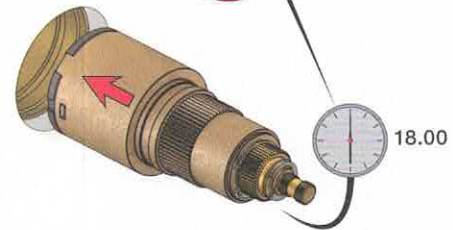

18.00

5 703182 430287
mnt VR3277 40999005

www.vola.com
vola

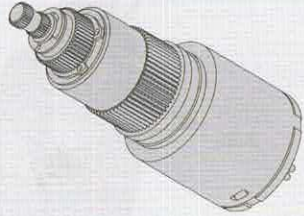

VOLA VR3277:
Skötsel
Maintenance
Wartung
Vedligehold
Nettoyage

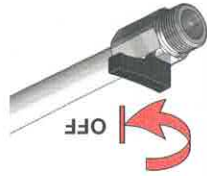

1



2



3



4



2.5 mm

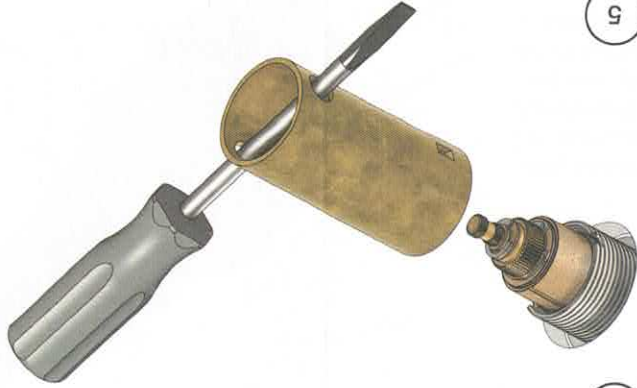

4



5

